

CALCULIMETRE de G. CHARPENTIER

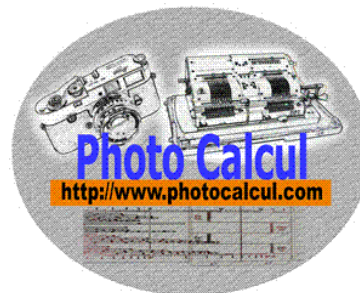
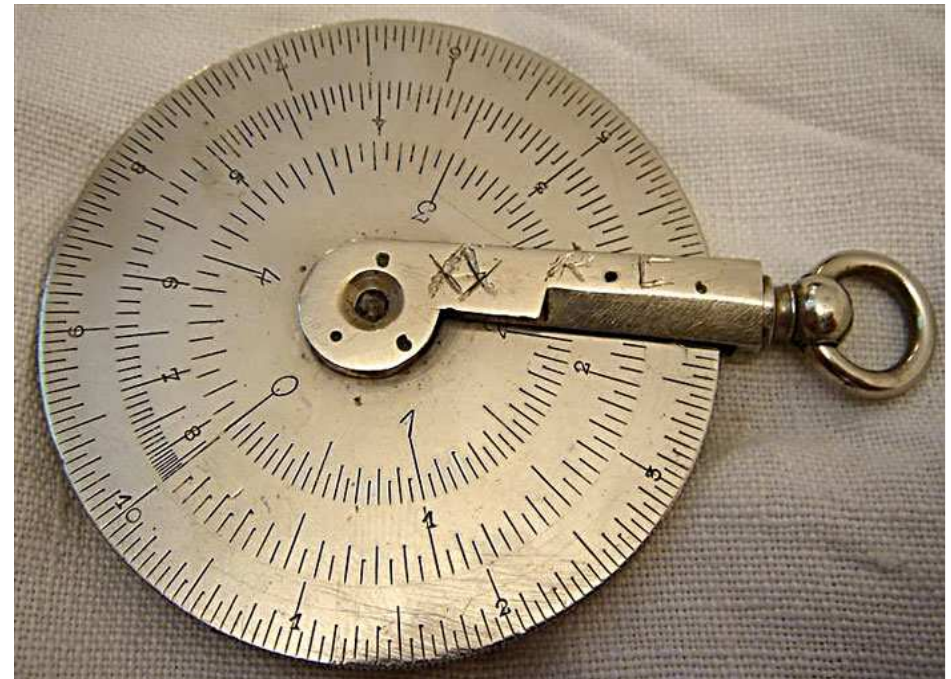
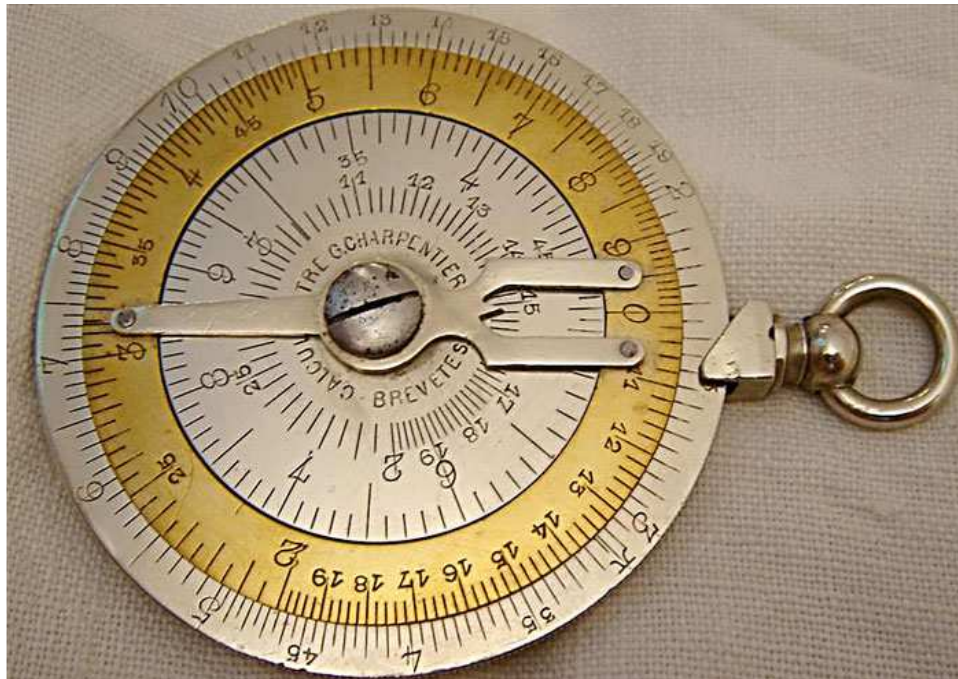

CALCULIMETRE de G. CHARPENTIER

Breveté en France : Décembre 1881

Fabriqué par Tavernier-Gravet, Keuffel & Esser,...

La meilleure présentation sur Internet (anglais) :

<http://retrocalculators.com/Charpentier.aspx>

Mini mode d'emploi graphique

Principales opérations

Multiplication

Division

Carrés

Cubes

Logarithmes décimaux

Sinus

Tangentes

Multiplication



| | | |
|----|-----|-----|
| 81 | 162 | 324 |
| 0 | 2 | 4 |
| | | |

$$81 \times 2 = 162$$
$$81 \times 4 = 324$$

Division

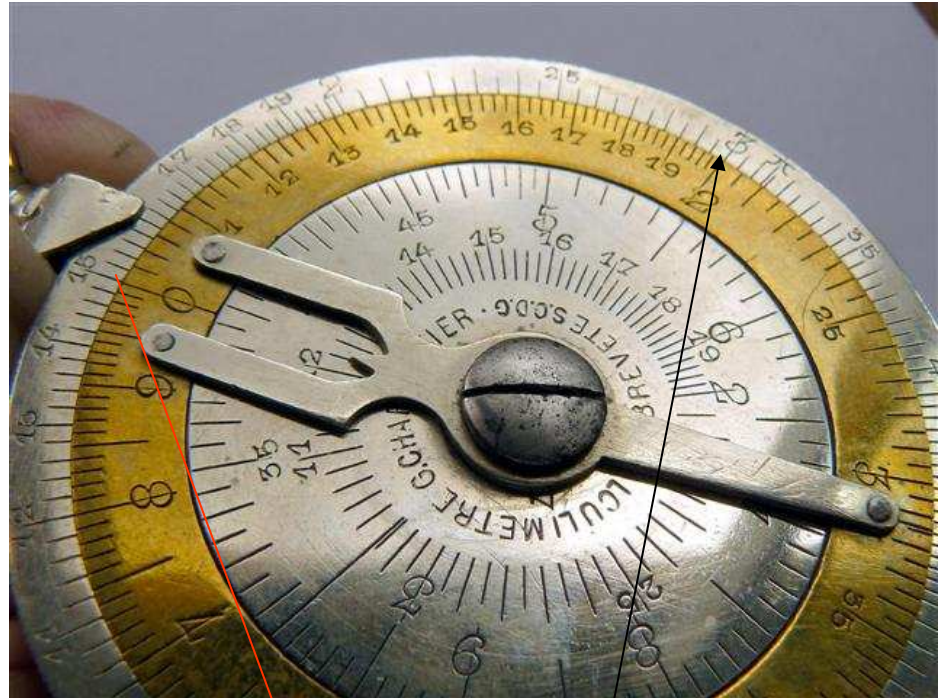

| | |
|----|---|
| 15 | 3 |
| 0 | 2 |
| | |

$$3 / 2 = 1,5$$

Carrés

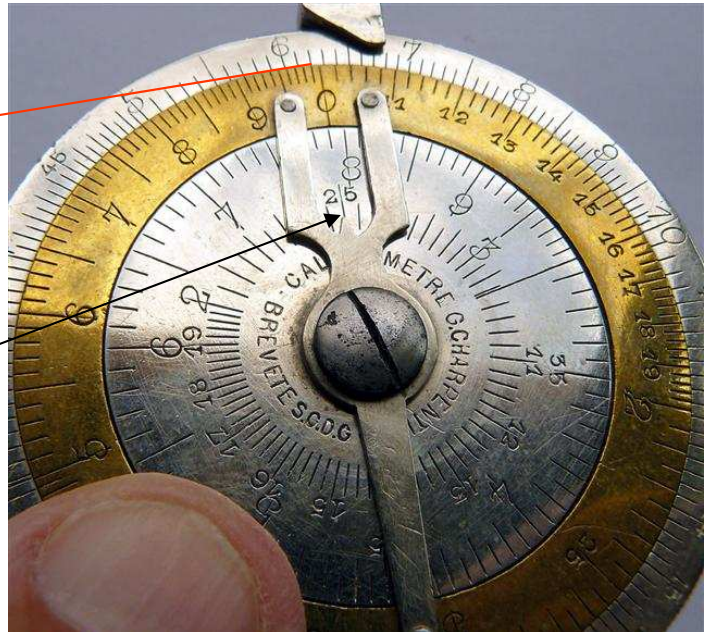
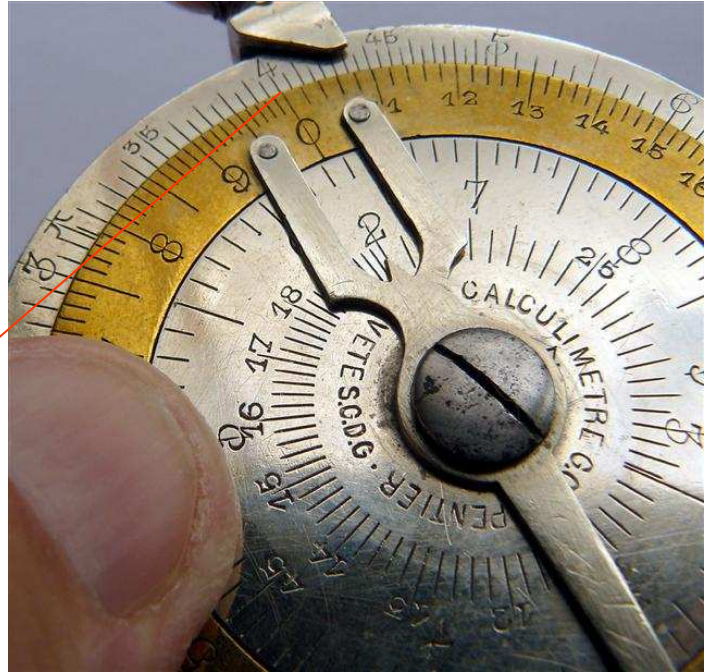
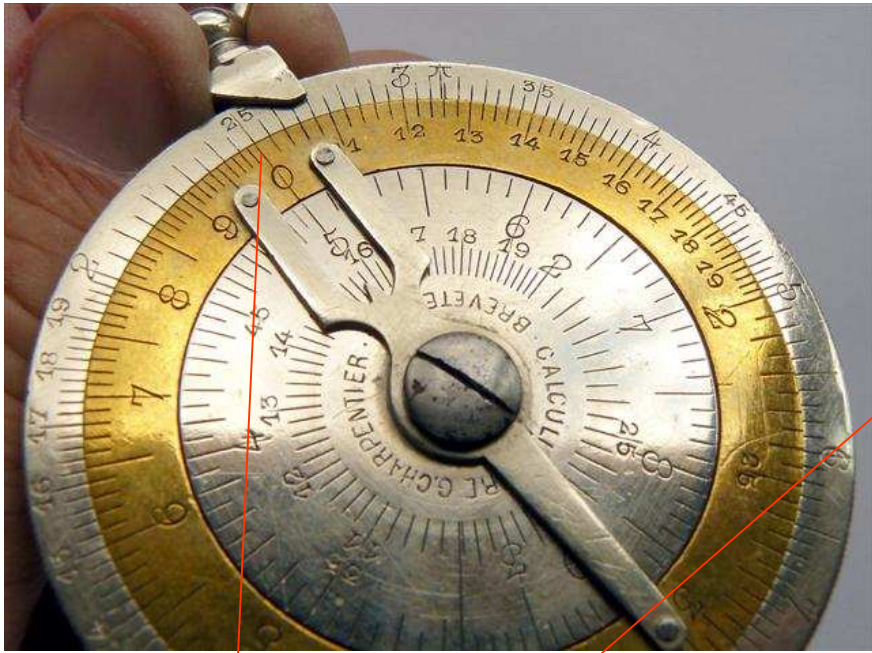

| | | |
|-------|-------|--------|
| 5^2 | 2^2 | 25^2 |
| 25 | 4 | 625 |
| 0 | 0 | 0 |
| 5 | 2 | 25 |

Cubes

$$5 \times 5 \times 5 = 125$$

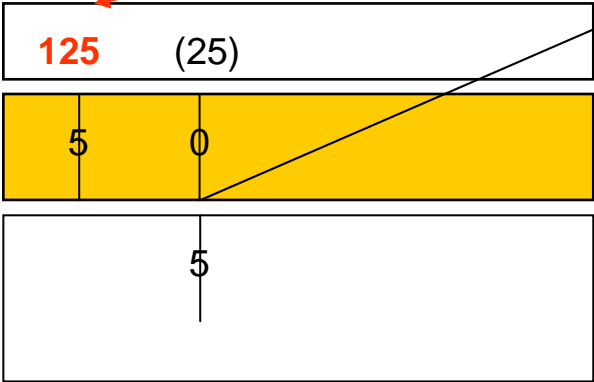

Logarithmes décimaux

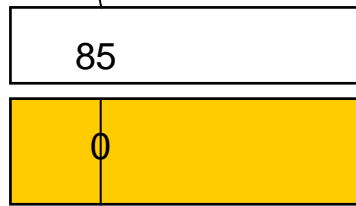

log 850

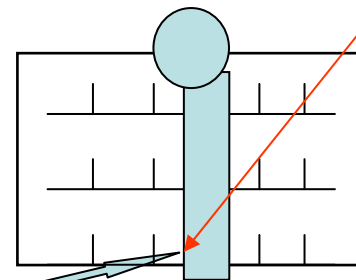
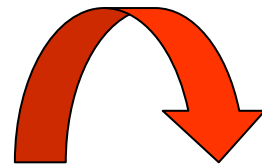

2,92942

Lignes trigonométriques : sinus et tangentes

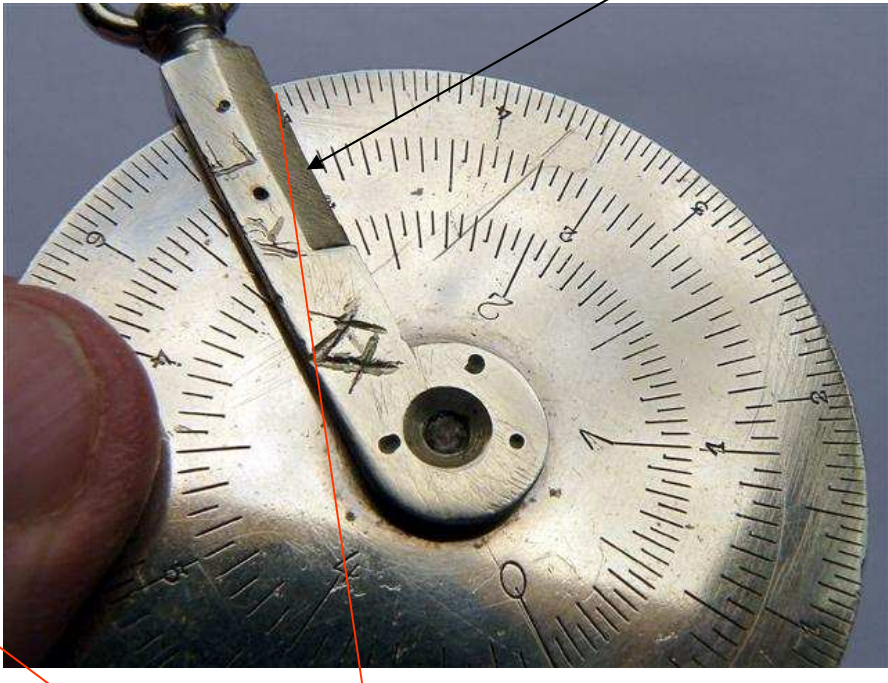
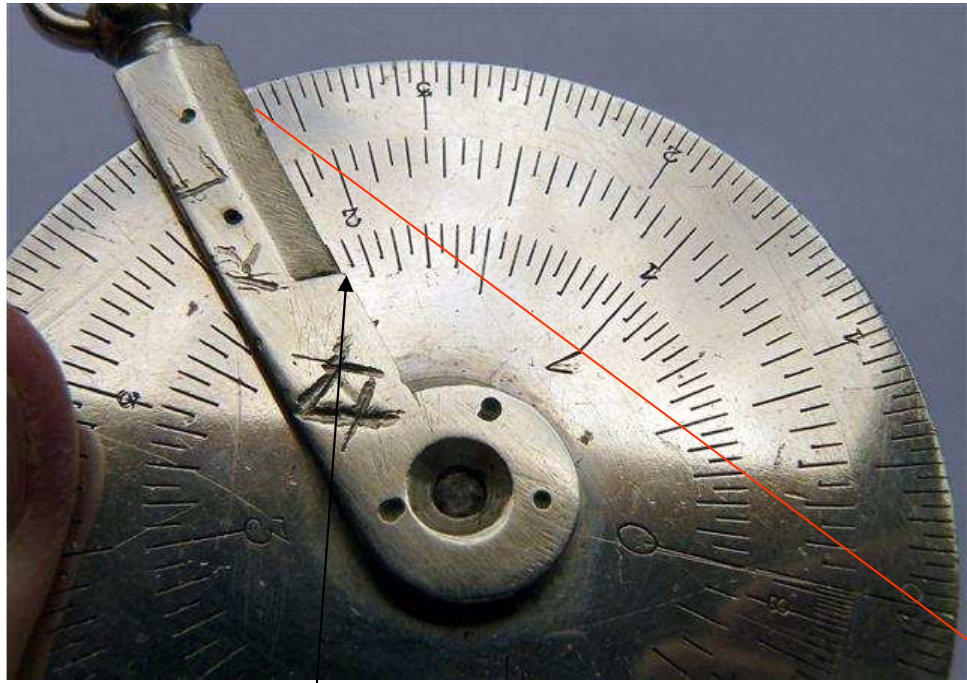

20° (tangente)

30° (sinus)

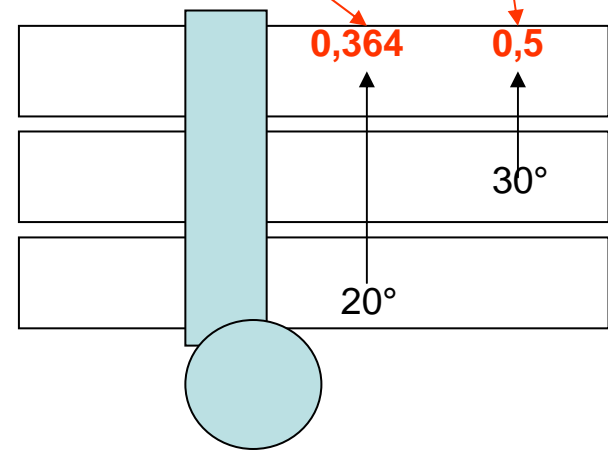

résultat

Calcul des sinus

Calcul des tangentes